

Service Manual

Sach-Nr./Part No.
72010-745.35

Zusätzlich erforderliche Unterlagen für den Komplettservice:

Additionally required Service Manuals for the Complete Service:

Service Manual

Sicherheit
Safety

Sach-Nr./Part No.
72010-800.00

CD 11



FINEARTS by grundig

CD 11 (9.54713-8151 / G.LE 38-51)

Es gelten die Vorschriften und Sicherheitshinweise gemäß dem Service Manual "Sicherheit", Sach-Nummer 72010-800.00, sowie zusätzlich die eventuell abweichenden, landesspezifischen Vorschriften!



The regulations and safety instructions shall be valid as provided by the "Safety" Service Manual, part number 72010-800.00, as well as the respective national deviations.

D

Inhaltsverzeichnis

	Seite
Allgemeiner Teil	1 - 2 ... 1 - 10
Meßgeräte	1 - 2
Technische Daten	1 - 2
Testmodus	1 - 3
Ausbauhinweise	1 - 4
Bedienhinweise	1 - 8
Schaltpläne und Druckplattenabbildungen	2 - 1 ... 2 - 14
Verdrahtungsplan	2 - 1
Schaltplan	2 - 3
Platinenabbildungen	2 - 7
IC Innenbeschaltungen	2 - 13
Ersatzteillisten und Explosionszeichnungen	3 - 1 ... 3 - 5
Explosionszeichnung Gerät	3 - 1
Explosionszeichnung CD-Laufwerk CDM12	3 - 3
Ersatzteilliste	3 - 4

Allgemeiner Teil

Meßgeräte / Meßmittel

Beachten Sie bitte das GRUNDIG Meßtechnik-Programm, das Sie unter folgender Adresse erhalten:

GRUNDIG electronics GmbH
Würzburger Str. 150
D-90766 Fürth/Bay
Tel. 0911/703-0, Fax 0911/703-4479

Technische Daten

Linearität Frequenzgang ($\pm 0,1\text{dB}$)	20...20000Hz
Signal- /Störabstand	96dB
Klirrfaktor (THD)	80dB
Dynamikbereich	96dB
Übersprechen (20...20000 Hz)	> 100dB
Phasenlinearität	< 0,5°
Intermodulation	> 80dB
Ausgangsspannung / Impedanz (Fixed output)	2,0V _{eff}
Stromversorgung	
Netzspannung	230V~
Netzfrequenz	50/60Hz
Leistungsaufnahme	10W
Abmessungen & Gewicht	
B x H x T	435 x 75 (+12) x 300mm
Gewicht	ca. 3,5kg

GB

Table of Contents

	Page
General Section	1 - 2 ... 1 - 12
Test Equipment	1 - 2
Technical Data	1 - 2
Test Mode	1 - 3
Disassembly Instructions	1 - 4
Operating Hints	1 - 10
Circuit Diagrams and Layout of PCBs	2 - 1 ... 2 - 14
Wiring Diagram	2 - 1
Circuit Diagram	2 - 3
Layout of PCBs	2 - 7
IC Block Diagrams	2 - 13
Spare Parts Lists and Exploded Views	3 - 1 ... 3 - 5
Exploded View Unit	3 - 1
Exploded View CD Drive CDM12	3 - 3
Spare Parts List	3 - 4

General Section

Test Equipment / Aids

Please note the Grundig Catalog "Test and Measuring Equipment" obtainable from:

GRUNDIG electronics GmbH
Würzburger Str. 150
D-90766 Fürth/Bay
Tel. 0911/703-0, Fax 0911/703-4479

Technical Data

Frequency response ($\pm 0,1\text{dB}$)	20...20000Hz
Signal-to-noise ratio	96dB
Distortion (THD)	80dB
Dynamic range	96dB
Stereo Crosstalk (20...20000Hz)	> 100dB
Phase linearity	< 0,5°
Intermodulation	> 80dB
Output voltage / impedance (Fixed output)	2,0V _{rms}
Power supply	
Voltage	230V~
Frequency	50/60Hz
Power consumption	10W
Dimensions & weight	
W x H x D	435 x 75 (+12) x 300mm
Weight	approx. 3.5kg

Testmodus

Starten des Testmodus

- Eine Disc einlegen.
- Gerät ausschalten.
- Die Tasten ▷ und ◀ gedrückt halten und das Gerät einschalten.
- Display zeigt 00 TEST.

Displaytest

- Taste ▷ drücken.
- Es werden jetzt die einzelnen Segmente des Displays der Reihe nach ein- und ausgeschaltet.

Servotests

- **Schlitten**
 - Taste ▷ drücken bis 01 TEST angezeigt wird.

- Taste ▷ bewegt den Schlitten nach vorne.
- Taste ◀ bewegt den Schlitten nach innen.

- **Focus**

- Taste ▷ drücken bis 02 TEST angezeigt wird.

- Bei Drehen der Disc per Hand ist ein Geräusch hörbar.

- **Disc Motor**

- Taste ▷ drücken bis 03 TEST angezeigt wird.

- Der Disc Motor läuft mit einer konstanten Geschwindigkeit.

Verlassen des Testmodus

- Gerät ausschalten.

Test Mode

Start the Test Mode

- Load a disc.
- Switch off the unit.
- Hold the buttons ▷ and ◀ depressed and switch on the unit.
- Display shows 00 TEST.

Display Test

- Press button ▷.
- The segments of the display are now being switched on and off.

Servo Tests

- **Sledge**
 - Press the button ▷ until 01 TEST is been displayed.

- **Focus**

- Press the button ▷ until 02 TEST is been displayed.

- **Disc Motor**

- Press the button ▷ until 03 TEST is been displayed.

- The disc motor starts with constant speed.

Exit Test mode

- Switch off the unit.

Notizen / Notes

Ausbauhinweise

1. Öffnen des Gehäuses (Fig. 1)

- Die 4 Schrauben (A) und die 2 Schrauben (B) herausschrauben.
- Den Deckel abheben.

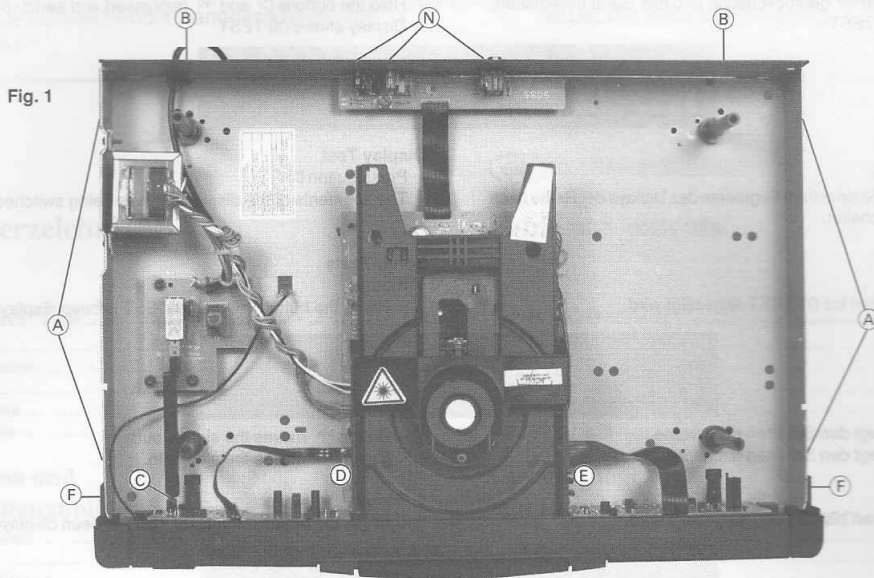

2. Ausbau der CD-Schublade (Fig. 2)

- Die CD-Schublade vorsichtig bis zum Anschlag herausziehen.
- Mit einem kleinen Schraubendreher die Rastung (G) nach rechts drücken und dadurch ausrasten.
- Die CD-Schublade kann jetzt ganz herausgezogen werden.

2. Removing the CD Tray (Fig. 2)

- Pull out the CD tray until its stop.
- Using a small screw driver, push the catch (G) to the right to disengage it.
- The CD tray can now be removed completely.

Fig. 2

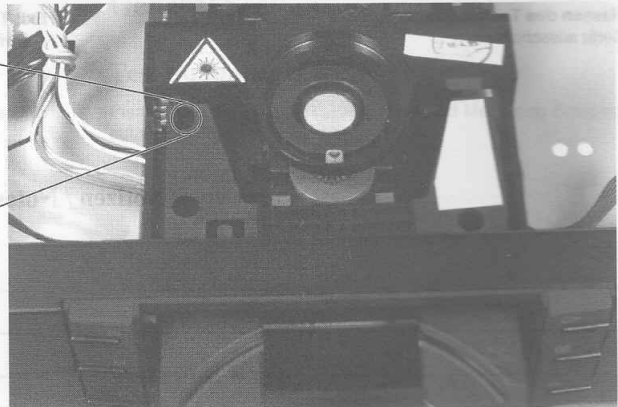
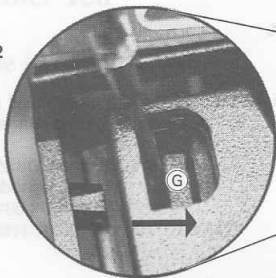

3. Ausbau der Frontplatte

- Die CD-Schublade ausbauen (s. Punkt 2).
- Die Rastung (C) (Fig. 1) der Netztaaste ausrasten.
- Die 2 Steckverbinder (D) und (E) (Fig. 1) abziehen.
- Die 2 Rastnasen (F) (Fig. 1) ausrasten.

3. Removing the Front Panel

- Remove the CD Tray (see para 2).
- Disengage the mains button (C) (Fig. 1).
- Disconnect the 2 plug-in-connections (D) and (E) (Fig. 1).
- Disengage the 2 catches (F) (Fig. 1).

4. Zerlegen der Frontplatte (Fig. 3 und 4)

- Die Schrauben (H) herauserschrauben und die Rastnasen (J) ausrasten.
- Die Leiterplatten können dann herausgenommen werden.

Fig. 3

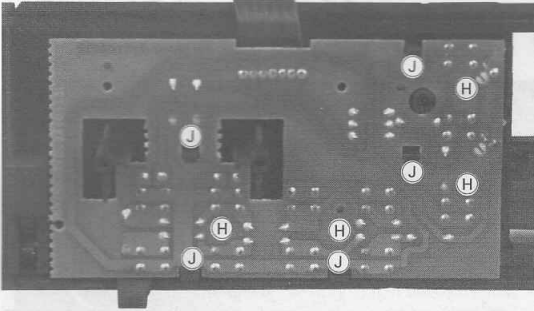

4. Disassembling of the Front Panel (Fig. 3 and 4)

- Undo the screws (H) and disengage the catches (J).
- The PCBs can now be removed.

Fig. 4

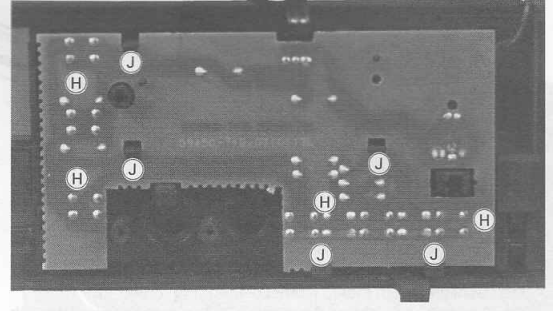

5. Ausbau des CD-Laufwerks (Fig. 5, 6 und 7)

- Die Frontblende ausbauen (s. Punkt 3).
- Die 2 Steckverbinder (K) und (L) abziehen.
- Die 3 Schrauben (M) herauserschrauben.
- Die 3 Schrauben (N) (Fig. 1) herauserschrauben.
- Das CD-Laufwerk mit der Chassisplatte und der Ausgangsplatte herausnehmen.
- Die 2 Steckverbinder (O) und (P) abziehen.
- Die 3 Schrauben (Q) herauserschrauben.
- Die Leiterplatte vorsichtig vom Laufwerk abheben und den Flexprint-Stecker (R) abziehen.
- Vor dem Öffnen des Flexprint-Steckers eine Büroklammer über die Flexprint-Leitung schieben. Beim Herausziehen der Flexprint-Leitung diese dann nach unten über die Kontakte schieben (MOS-Bauteile)!

Fig. 5

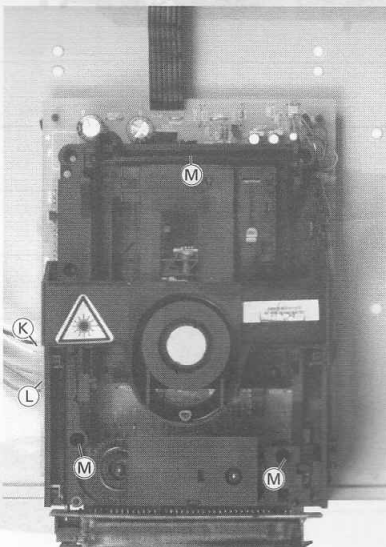

5. Removing the CD-Drive (Fig. 5, 6 und 7)

- Remove the front panel (see para 3).
- Disconnect the 2 plug-in-connections (K) and (L).
- Unscrew the 3 screws (M).
- Unscrew the 3 screws (N) (Fig. 1).
- Remove the CD drive together with the chassis board and the output board.
- Disconnect the 2 plug-in-connections (O) and (P).
- Unscrew the 3 screws (Q).
- Carefully lift off the PCB from the drive and disconnect the flexprint connector (R).
- Before opening the flexprint connector, put a paper clip on the flexprint. When pulling out the flexprint, push the paper clip over the contacts (MOS components)!

Fig. 6

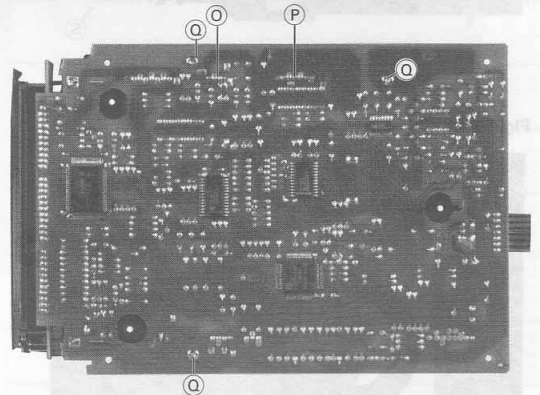
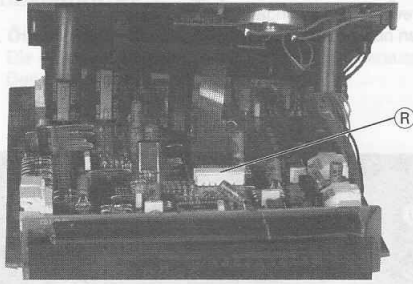
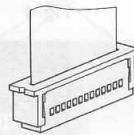

Fig. 7



Öffnen eines Flexprint-Steckers

Opening a Flexprint Connector



2

1

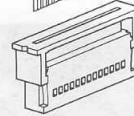
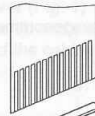

Kurzschließen einer Flexprint

Leitung Shortening of a Flexprint

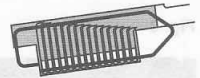

6. Zerlegen des CD-Laufwerks (Fig. 8 - 11)

- Das CD-Laufwerk ausbauen (s. Punkt 5).
- Den Schlitten nach rechts hochschieben (Fig. 8 und 9).
- Der Schlitten kann jetzt an der rechten Seite angehoben und danach ausgehängt werden (Fig. 10 und 11).
- Beim Wiedereinsetzen auf richtigen Sitz in den Führungen Ⓢ achten.

6. Disassembling the CD Drive (Fig. 8 - 11)

- Remove the CD Drive (see Para 5).
- Move the sled to the right (Fig. 8 and 9).
- The sled can now be lifted on the right side and can be removed (Fig. 10 and 11).
- Take care of the guide rail Ⓢ when fitting the sled.

Fig. 8

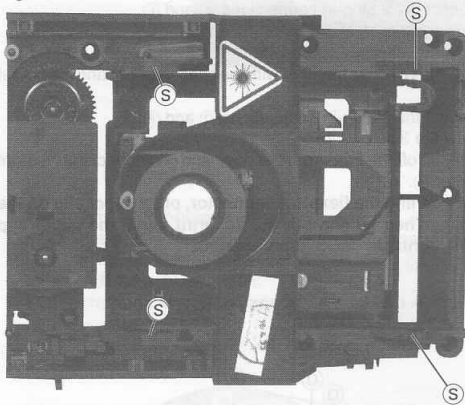

Fig. 9

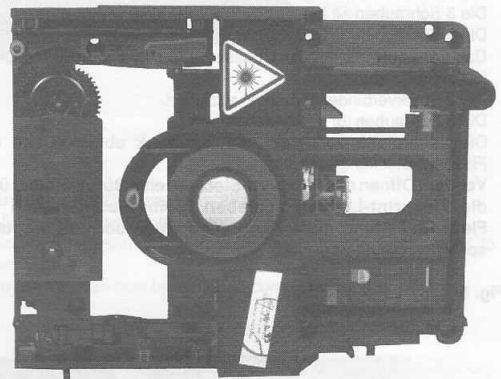

Fig. 10

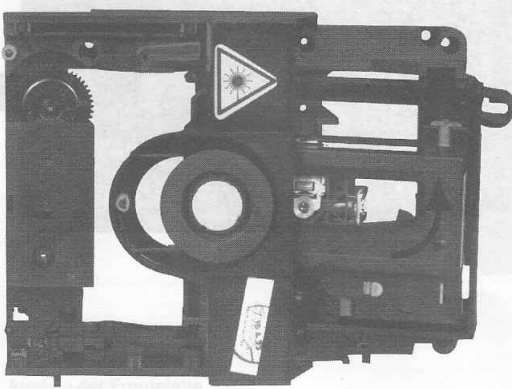
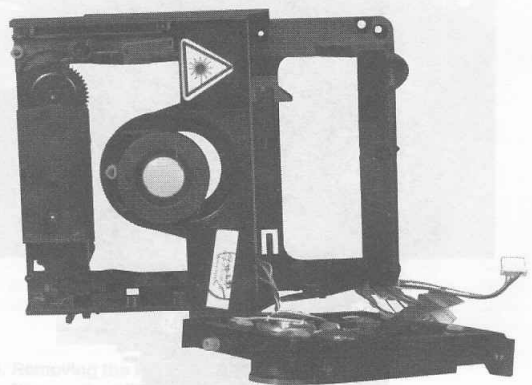

Fig. 11



- Das CD-Laufwerk ausbauen (s. Punkt 5).
- Die Führung Ⓢ (Fig. 1) wie Notwendig ausrichten.
- Die 2 Steckverbinder Ⓢ und Ⓢ (Fig. 1) abstecken.
- Die 2 Federn Ⓢ (Fig. 1) ausbauen.

- Remove the CD Drive (see Para 5).
- Disengage the main bearing Ⓢ (Fig. 1).
- Disconnect the 2 plug-in connectors Ⓢ and Ⓢ (Fig. 1).
- Disengage the 2 springs Ⓢ (Fig. 1).

Operating Hints

Note: This chapter contains excerpts from the operating instructions. For further particulars please refer to the appropriate user instructions the part number of which is indicated in the relevant spare parts list.

Installation

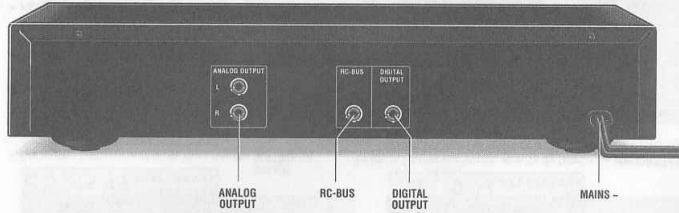

Setting up

- If you want to set up your CD player on a shelf, in a cabinet or any other type of enclosure, always ensure that sufficient ventilation is available. An open space of at least 3 cm at the sides and the top, and 5 cm at the back of your system is required.
- Place the power supply cable as far as possible from the sound signal lines in order to avoid disturbing signal interference.
- When making connections, always note the identification markings on the cables and sockets, as well as those on the back of the unit, in order to avoid improper connections. Improper connections can considerably impair sound quality.

Power supply connection

- Only connect the unit to a 230V-, 50/60 Hz a.c. power source.
- If you want to switch your unit on and off via an amplifier from this series, or with the system remote control, connect the mains plug of the CD player to one of the **AC OUTLETS** of your amplifier. To use this capability, ensure that the power switch of the CD player is switched to the **ON** position. The amplifier's power switch can then be used as the main switch for all the units.
- Always ensure that the voltage indicated on the unit's rating plate agrees with your local power supply. If it is not the case, consult your dealer or customer service center. The rating plate is found on the back of the unit.

ⓘ Important Information for Units sold in Great Britain

Units sold in GB are suitable for operation from a 230V AC, 50 Hz mains supply. In case this appliance is supplied with a Safety Standard Approved mains lead fitted with a non-rewireable 13 Amp mains plug which, if unsuitable for your socket, should be cut off and an appropriate plug fitted by a qualified electrician. The fuse and fuse holder must be removed from the plug as accidental insertion of the redundant plug into a 13 Amp socket is likely to cause an electrical hazard.

Note: The covered plug must be destroyed to avoid a possible shock hazard should it be inserted into a 13 Amp socket elsewhere.

If it is necessary to change the fuse in the non-rewireable plug, the correct type and rating (5 Amp ASTA or BSI approved BS 1362) must be used and the fuse cover must be refitted. If the fuse cover is lost or damaged the lead and plug must not be used until a replacement is obtained from your dealer.

If a non-rewireable plug or a rewireable 13 Amp (BS 1363) plug is used, it must be fitted with a 5 Amp ASTA or BSI approved BS 1362 fuse. If any other type of plug is used it must be protected by a 5 Amp fuse either in the plug or at the distribution board.

Important: The wires in the mains lead are coloured in accordance with the following code: **BLUE - NEUTRAL, BROWN - LIVE**. As the colours of the wires in the mains lead of your appliance may not correspond with the coloured markings identifying the terminals in your plug, proceed as follows: Connect the **BLUE** coloured wire to the plug terminal marked with the letter 'N' or coloured black. Connect the **BROWN** coloured wire to the plug terminal marked with a letter 'L' or coloured red.

In no circumstances must any of the wires be connected to the terminal marked with a letter 'E', earth symbol ⚡, coloured green or green and yellow.

Replacement mains lead can be obtained from your dealer.

Connection to the amplifier

Your CD player should be connected to the corresponding input sockets on the amplifier.

- Connect the **ANALOG OUT** sockets to the **CD** input sockets on the amplifier. When connecting the cables, ensure the proper arrangement of the stereo channels: **L** = left channel (white), **R** = right channel (red).

Digital output

- Connect the socket **DIGITAL OUT** with a digital input of an amplifier, receiver, or digital recorder.

RC-BUS connection

- If you would like to use your amplifier to switch on and remotely control your CD player (**DIRECT OPERATION TECHNIQUE, D.O.T.**), the system bus line must be connected to the input socket **CD** of the amplifier. It is then also possible to operate the unit via the infrared remote control.
- Connect the **RC-BUS** socket to one of the **RC-BUS** sockets of your amplifier of this series.

D.O.T. (Direct operation technique)

An 'intelligent' data bus connection in your unit makes it possible for individual components of this series to 'communicate' with each other.

To take advantage of this capability, the CD player must be connected to the input sockets marked **CD** on the amplifier and the **RC-BUS** connection (orange socket on the back of the unit) must be made.

The **D.O.T.** function allows automatic input selection of the amplifier.

- If you press the **⇄**, **SHUFFLE**, **⇄** or **⇄** buttons on the CD player, the amplifier automatically selects the input **CD**. The only requirement is that the function **D.O.T.** on the amplifier is switched on.

D.O.T. also allows the **CD COPY** function to be carried out by pressing just one button. (see page 12)

Warning

This label is attached to the back of your unit.

CLASS 1 LASER PRODUCT

CLASS 1 LASER PRODUCT means that the laser's construction makes it inherently safe so that the legally prescribed maximum permissible radiation values can never be exceeded.

CAUTION: Using any equipment or devices other than those described and specified in these operating instructions, or tampering with the unit in any way, can result in dangerous exposure to radiation.

Operating elements

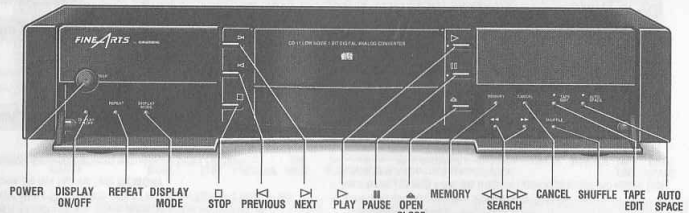

Front of the CD player

- POWER** This button is used for switching the CD player on and off.
- DISPLAY ON/OFF** You can use this button to switch the display on and off.
- REPEAT** This button is used to turn the CD or programme repeat on and off.
- DISPLAY MODE** This is used to change the information shown in the display.
- STOP** This button is used to end all functions.
- PREVIOUS** This button is used to skip to the previous track.
- NEXT** This button is used to skip to the next track.
- PLAY** This button is used to start or restart playback.
- PAUSE** This button is used to briefly interrupt playback (**PAUSE**), without changing the unit settings.
- OPEN/CLOSE** This button is used to open and close the CD compartment.
- MEMORY** This is used to call up the programming mode or to save individual tracks.
- SEARCH** These buttons are used to start backward **◀◀** or forward **▶▶** search.
- CANCEL** This button is used to omit individual tracks from the programme or to delete the complete programme.
- SHUFFLE** This button is used to turn the shuffle function on and off, which mixes up the track order.
- TAPE EDIT** This button is used to adjust the CD playing time to the length of the cassette you are recording to.
- AUTO SPACE** This button is used to insert pauses between recordings that are necessary for the **MUSIC SEARCH** function on cassette decks.

General information

To remove a CD from its case, hold it on its outside edge with the index finger and thumb.

Do not touch the surface of a CD with your fingers. Always store a CD in its case when it is not being used.

Place a CD in its case with the label facing up and press down lightly.

Do not leave CD's for any length of time in direct sunlight or other places where high temperatures may occur, such as in the vicinity of heating apparatus. Do not expose the CD's to humidity or rain.

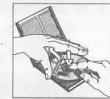

Remote Control



The buttons on the remote control have the same functions as the corresponding ones on the CD player.

Extra buttons:

10-button keypad for the direct selection of tracks. If you wish to select a track number from 1...9, briefly press the corresponding button. In the case of two-digit track numbers, first enter the first digit by keeping the corresponding button depressed. Then enter the second digit.

VOLUME +/- – These buttons are used to adjust the volume of the connected amplifier or receiver of this series (+ louder, – softer) The **+** button is used to cancel the mute function (⇄ button).

⇄ – This button is used to switch your amplifier or receiver to the **STAND BY** mode.

⇄ – This button is used to interrupt the playback from a receiver or amplifier (mute mode) without changing the unit settings.

⇄ – Besides ending all functions this button can also be used to close the CD compartment.

Changing the batteries

If the range of your infrared remote control seems to decrease, or if certain individual functions can no longer be carried out, you should replace the batteries.

Two mignon 1.5 Volt LR03 size AAA are required. To change the batteries, open the compartment on the back of the remote control. Ensure that the batteries are inserted properly (note the markings in the compartment).

And in the interest of the environment: Remember that batteries must always be disposed of properly.

Inserting a CD

Open the CD compartment by pressing **⇄**. Insert the CD so that the printed side of the disc is facing up. Place CD singles (8 cm) in the depression in the compartment.

Press **⇄** again. The compartment closes. The CD compartment can also be closed by hand. After the compartment has closed, the unit reads the contents of the CD.

Information on the number of tracks, playing length, etc. are recorded there. This information is shown in the display.

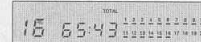

Operation

Switching on and off

- When you want to switch your CD player on, press the **POWER** button. The yellow LED in the middle of the button indicates that the unit is on.
 - button depressed: **POWER ON**
 - button not depressed: **POWER OFF**
- If you have not inserted a CD, "DISC" appears briefly in the display, and then —



- After the unit has been switched on, it is always in the **STOP** mode.
- When you want to switch the unit off, simply press the **POWER** button again.

Switching the display off

The display is automatically switched **ON** whenever the unit is activated.

- Press the **DISPLAY ON/OFF** button to switch the display **OFF**. Pressing any button will cause the display to come on again for approx. 5 seconds. The next time you activate the unit, or if you press the **DISPLAY ON/OFF** button again, the display will remain illuminated.

CD playback

- Press **>** on the unit (or on the remote control) to start playback. The display shows the number of the track being played as well as the elapsed playing time (relative playing time).

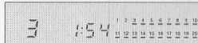

The display can also show you additional information.

- Press **DISPLAY MODE** on the remote control and the display shows you the CD's remaining playing time, **REMAIN**.

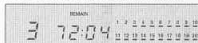

- If you press this button once more, the display shows the total playing time and the total number of tracks.

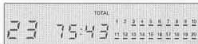

- A negative time display shows the pauses between the tracks.



- If you press **>** again, the running track will be restarted (**REPLAY** function).
- If you want to stop playback without changing the unit settings, press **II**. A yellow indicator in the button comes on.
- While playback is interrupted, you can press **<** **>** to skip to another track, or press **<<** **>>** to search for a certain passage.
- If you want to continue with playback, press **III** or **>** once more.
- To stop playback, press **□** (**STOP**).

Changing the display

- You can call up various information in the display by pressing the **DISPLAY MODE** button.
 - The displays changes according to the operating mode.

Skip function (TRACK NEXT/PREVIOUS)

- By pressing **>** you can skip to the beginning of the next track in the track sequence (**NEXT**), and by pressing **<** you can skip to the beginning of the preceding track (**PREVIOUS**).
- While in **STOP** mode you can choose a certain track.
 - Playback begins immediately.

Fast search (SEARCH)

- By pressing **<<** or **>>**, you activate the fast search (**SEARCH**) in the corresponding direction.
 - During the fast search procedure you can listen to the tracks.
 - After approx. 5 seconds the unit's mute function is activated.

REPEAT function

The repeat function allows you to repeat the entire CD (or your programme).

- By pressing the **REPEAT** button, you activate the repeat function; by pressing the button again you deactivate the repeat function.
- The display shows you the function you have chosen.



SHUFFLE function

- By pressing **SHUFFLE** you activate the shuffle function which mixes up the order of the CD tracks. A random number generator selects the order of the tracks to be played.

- All operating functions continue to function as during normal playback.
- The random number generator also controls the skip function.
- The display shows the function you have selected.



- The function is deactivated by pressing **□**, **II** or **SHUFFLE**; in this case the remaining tracks are played in their normal order.
- The shuffle function is not possible during playback of a programme.

Programming

You can programme your own track sequence for each CD. The order of the programmed tracks determines the order in which they are played. Each track can be stored as often as you like. The time display shows you the total playing time of the programme.

There are two methods of programming the desired track sequence. You can enter a programme in the **STOP** mode or in the **PLAY** mode.

You can store a sequence of up to 30 tracks. (see next page)

Operation

Programming in STOP mode

- Insert a CD and close the compartment.
 - The CD player reads the contents of the CD. The display shows the total playing time and the number of tracks.
- Press **MEMORY** to select the **PROGRAM** mode.
 - At the left, the display shows the number of the track you have selected, next to it the total playing time of programme, and at the right it shows the "track grid". Here you can see which tracks you have stored in the sequence.



- Select the first track you want to programme with **<** and **>**.
 - The track number flashes in the "track grid".
 - The display shows the time which will be the total time of your programme when you store the selected track. In this way you can easily search for tracks which fill in your program to a desired total time (e.g. for recording purposes). See also TAPE EDIT function.
- By pressing **MEMORY**, the track is stored in your programme.
 - The track number at the right stops flashing and is now marked with a dash.



- Choose the next track you wish to include in your programme and press **MEMORY** to save it.
 - The playing time display is updated and the track number is marked with a dash.
- You can leave the programme mode by pressing the **□**, **III** or **>** button.

Programming in PLAY mode

You can also enter a programme while a CD is playing.

- Press **MEMORY**.
 - The number of the current track flashes.
 - If you wish to add this track to your programme, press **MEMORY** again.
 - The track number stops blinking and is now marked with a dash.



- If you wish to add a track to your programme other than the one currently being played, press the **<** or **>** button.
- Save your selection by pressing **MEMORY**.
- You can leave the programme mode by pressing the **□** button.

Programme playback

- To play the programme you have created, press **>** (**PLAY**).
 - All functions of the playback mode continue to function.

Changing the programme

It is possible to change the programme you have created; you can add additional tracks or delete tracks from your programme.

- If you wish to add an additional track, select it by pressing **<** **>** on the keypad of your remote control. The corresponding track number blinks.
- Use **MEMORY** to add the track to your programme.
- If you wish to delete a track you can do so by selecting the track and then pressing **CANCEL**.
 - The playing time display is continuously updated.

Deleting the programme

- To delete the entire programme, press **CANCEL** while in the **STOP** mode.
- Opening the compartment (**II**) or shutting off the unit also deletes the programme.

Copying from a CD to cassette (CD-COPY)

If you have a cassette deck of this series, you can record from a CD to a cassette by pressing just one button.

In addition, you can also optimally record individual CD tracks or programmes on both sides of the cassette so that no tracks are cut off in the middle, or so that there is not an excessive amount of blank tape on one side of the cassette.

- First there must be a cassette in the cassette compartment and a CD in the CD player.
- Both units must be connected via bus lines (see page 9).
- Prepare the cassette tape by winding to the desired tape position and select the desired tracks on the CD player.
- Now press **CD COPY** on the cassette deck to start the copying procedure.
 - The cassette deck starts first in order to take up approx. 6 seconds of tape leader. The CD player then starts automatically.
 - During the recording procedure you can only use the **□** (**STOP**) or **II** (**OPEN/CLOSE**) buttons. All other functions are deactivated.
 - If the CD player is the first unit to stop playback, it automatically sends a corresponding command to the cassette deck and recording is stopped.
 - If the respective side of the tape reaches the end first, the CD player switches to **PAUSE**.
- If you want to continue recording on the other side of the cassette, turn the cassette over and press the **CD-COPY** button again.
 - The tape leader is taken up, and the CD starts at the beginning of the track just played.

TAPE EDIT function

This function notifies the CD player as to the playing time of a cassette tape.

- Press the **TAPE EDIT** button to call up the entries C 46, C 60, C 90, C 100, C 110, C 120 one after another.

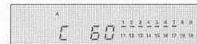

- Select the corresponding playing time of the cassette.
 - After a brief pause the unit will show you the total playing time and which tracks will be recorded onto the A side of the cassette.

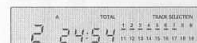

- By pressing the **DISPLAY MODE** button you can change the display so that it shows you the tracks to be recorded onto the B side of the tape.
- Start the **CD COPY** function on the cassette deck.
 - It starts to record on side A. When it is finished, the display shows the tracks that will be recorded onto the B side.
- This function can also be used to record a programme that you have saved.

AUTO SPACE function

If you are using a cassette deck that is accordingly equipped, you can use the **MUSIC SEARCH** function. In order to do so, you must leave silent pieces between the tracks.

- By pressing the **AUTO SPACE** button, the CD player automatically generates a 4-second recording pause.

Schaltpläne und Druckplattenabbildungen Circuit Diagrams and Layout of PCBs

Verdrahtungsplan Wiring Diagram

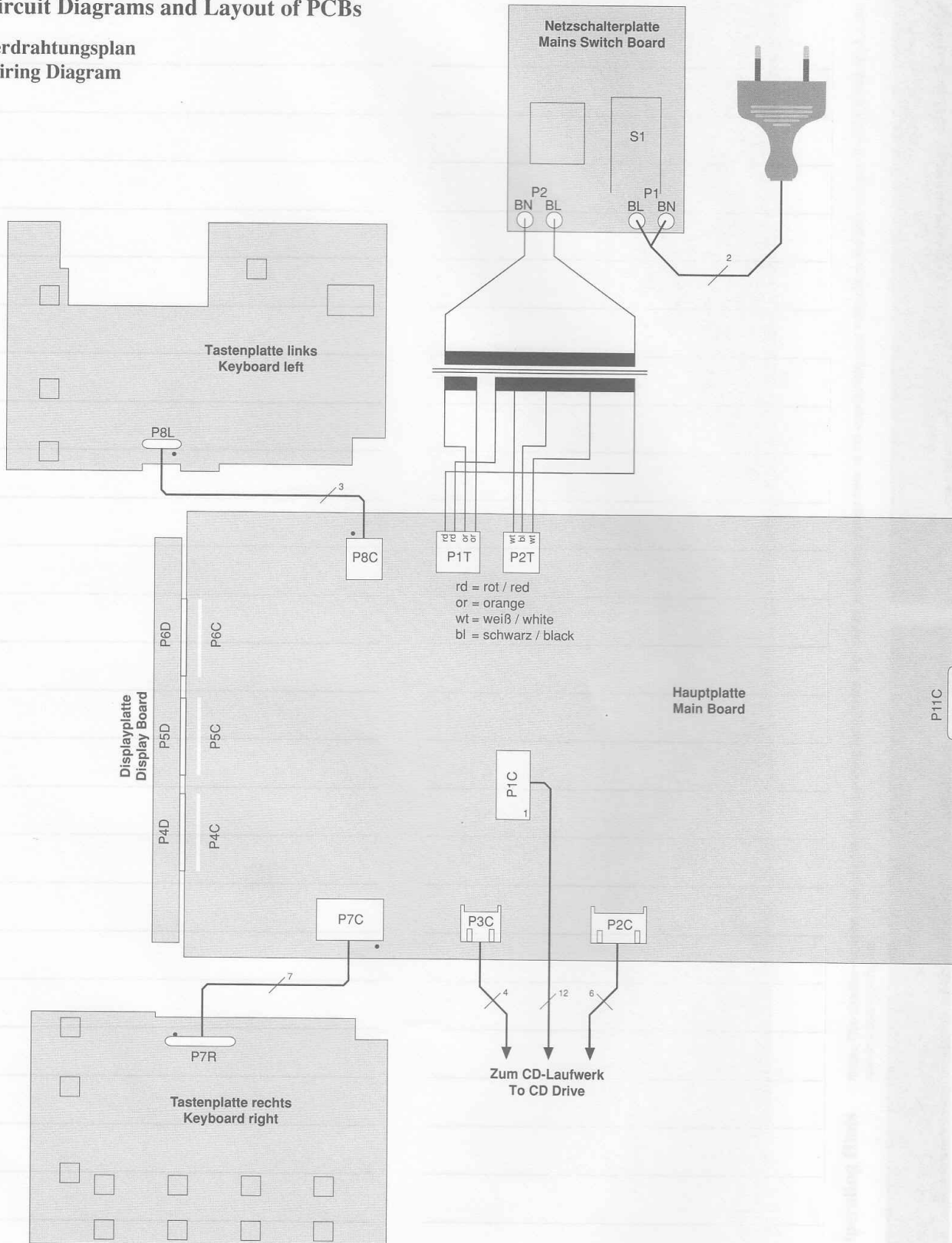

Öffnen eines Flexprint-Steckers
Opening a flexprint connector

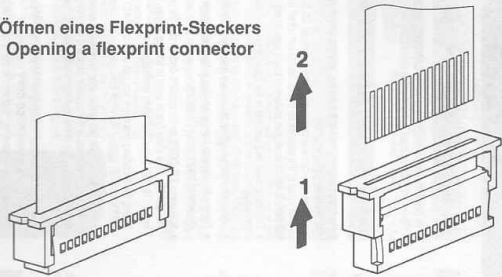

Belegung der Flexprintleitung in P1C
Flexfoil Connections in P1C

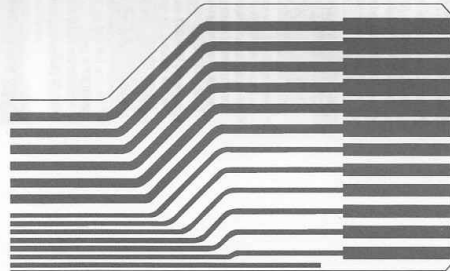

- 1: Radial -
- 2: Focus +
- 3: Focus -
- 4: Radial +
- 5: GND
- 6: + Laser
- 7: Substrate
- 8: D1
- 9: D2
- 10: D3
- 11: D4
- 12: D5

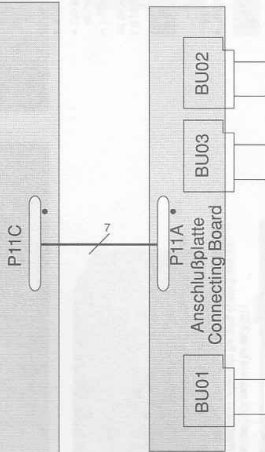

Schaltbild der Laser-Einheit
Circuit Diagram of Laser Unit

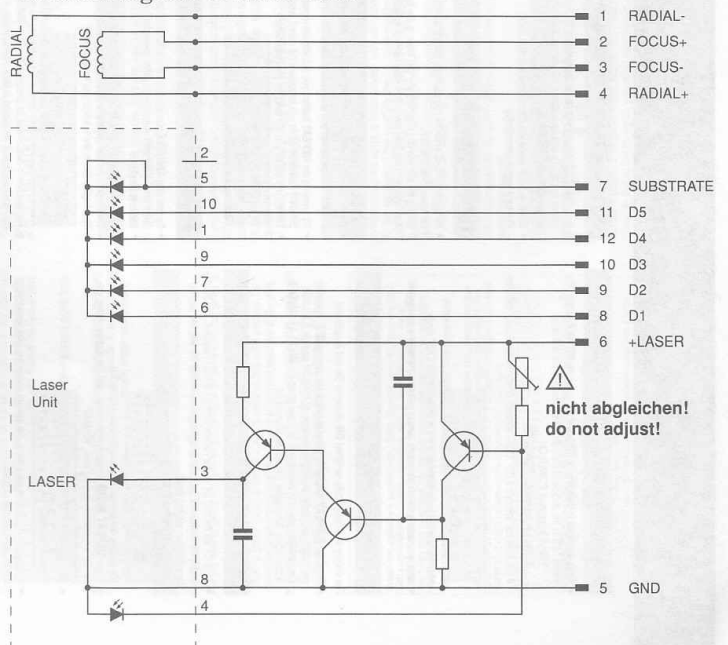

Operating Instructions

Schaltplan CD 11 Circuit Diagram CD 11

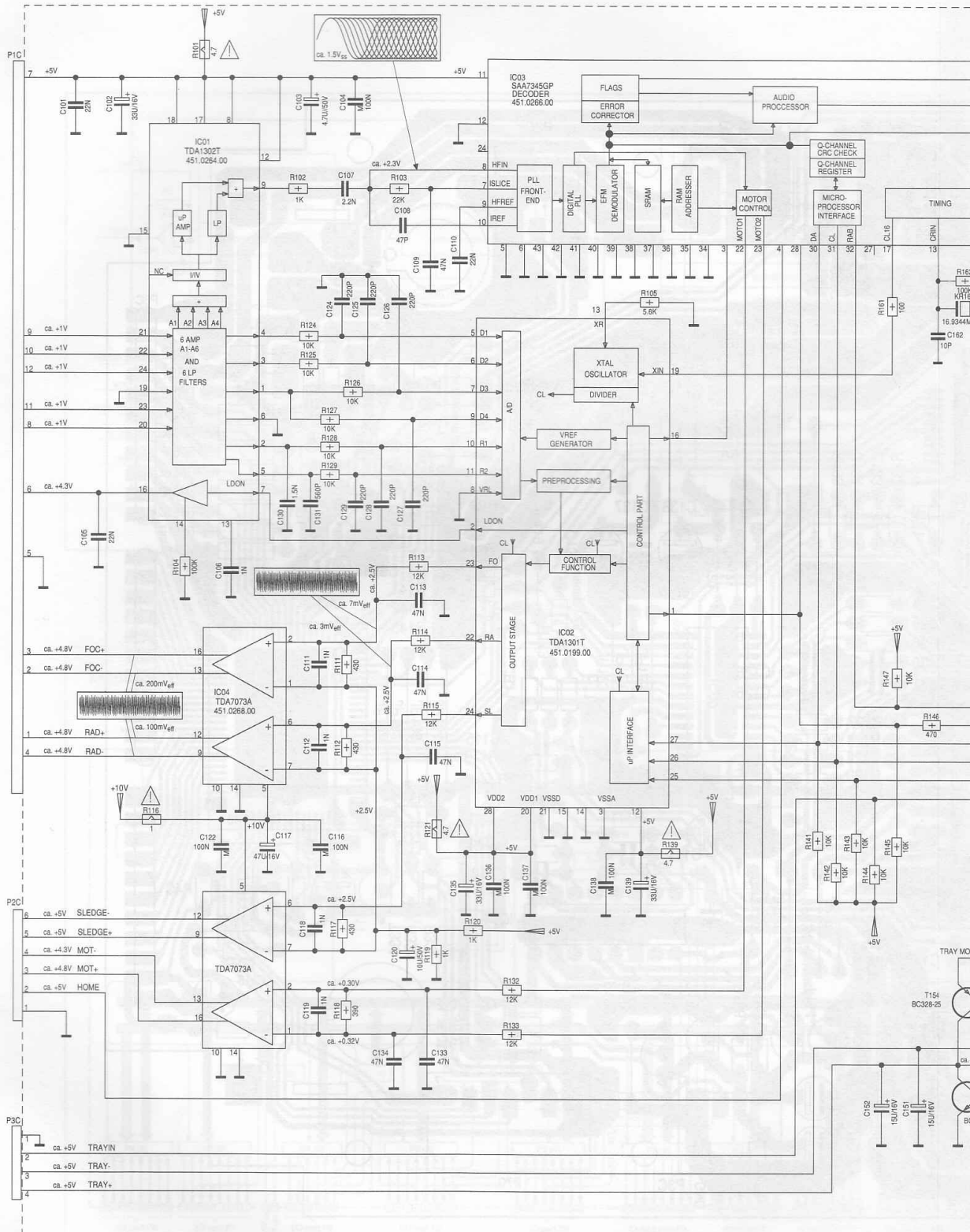

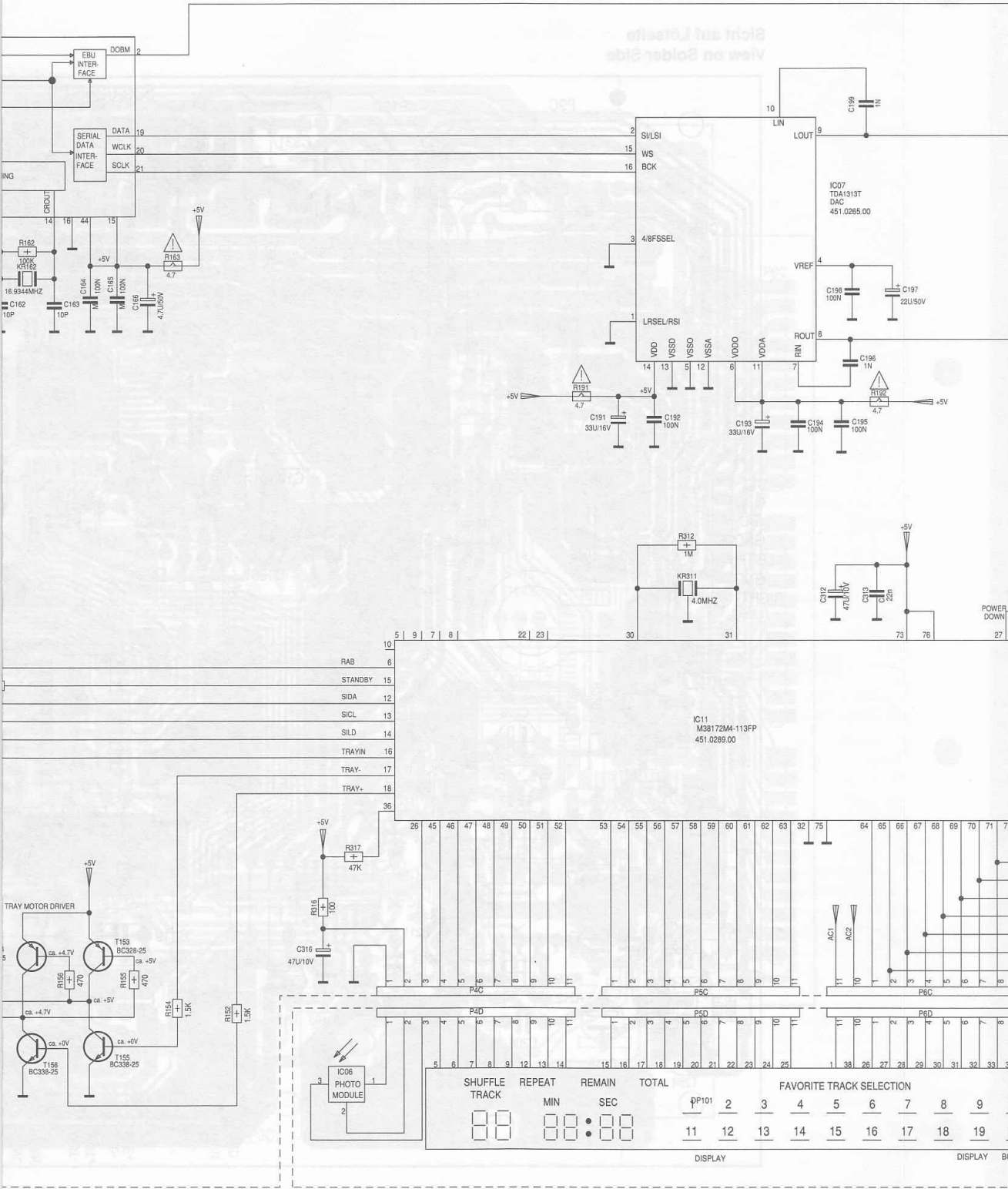

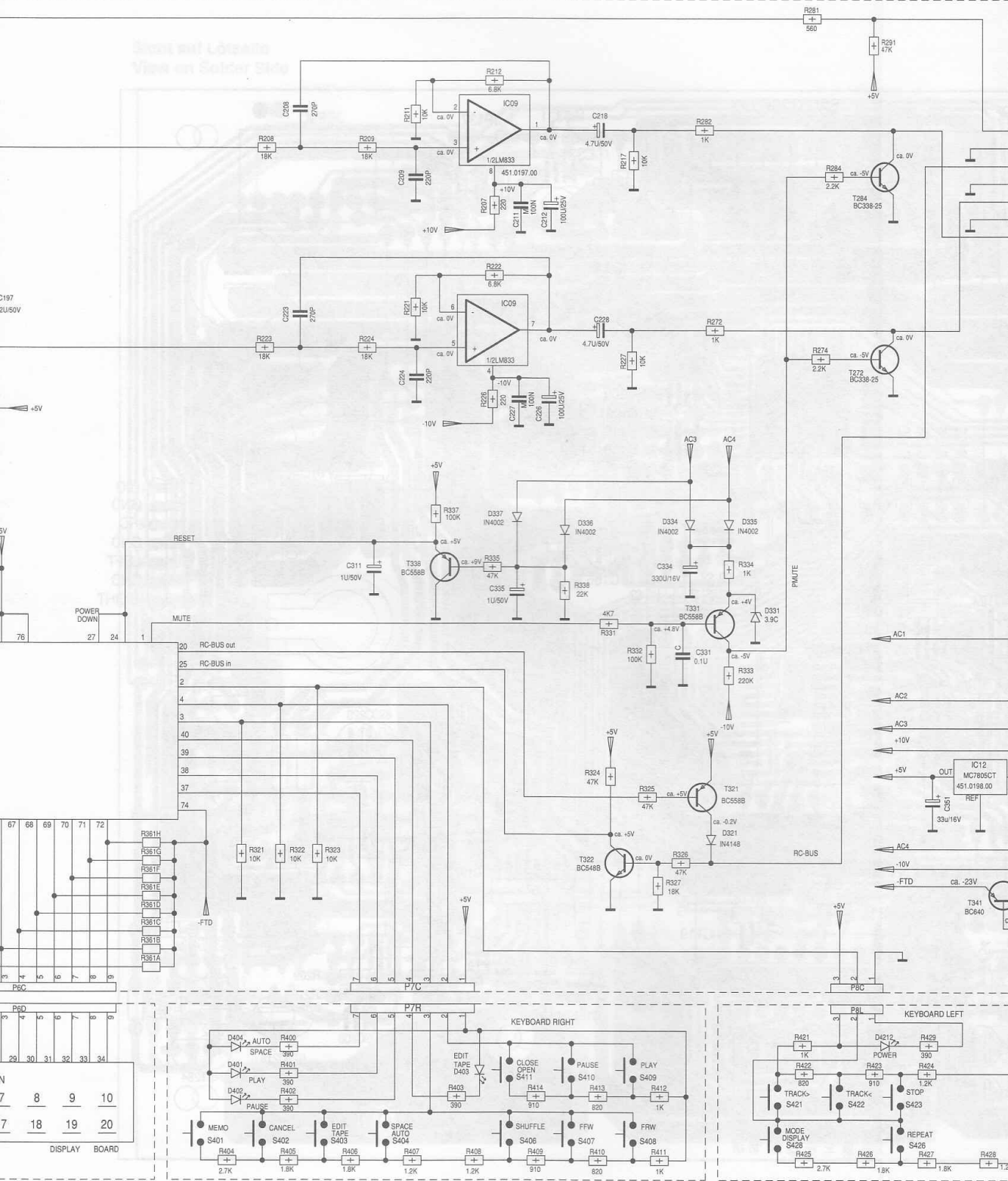

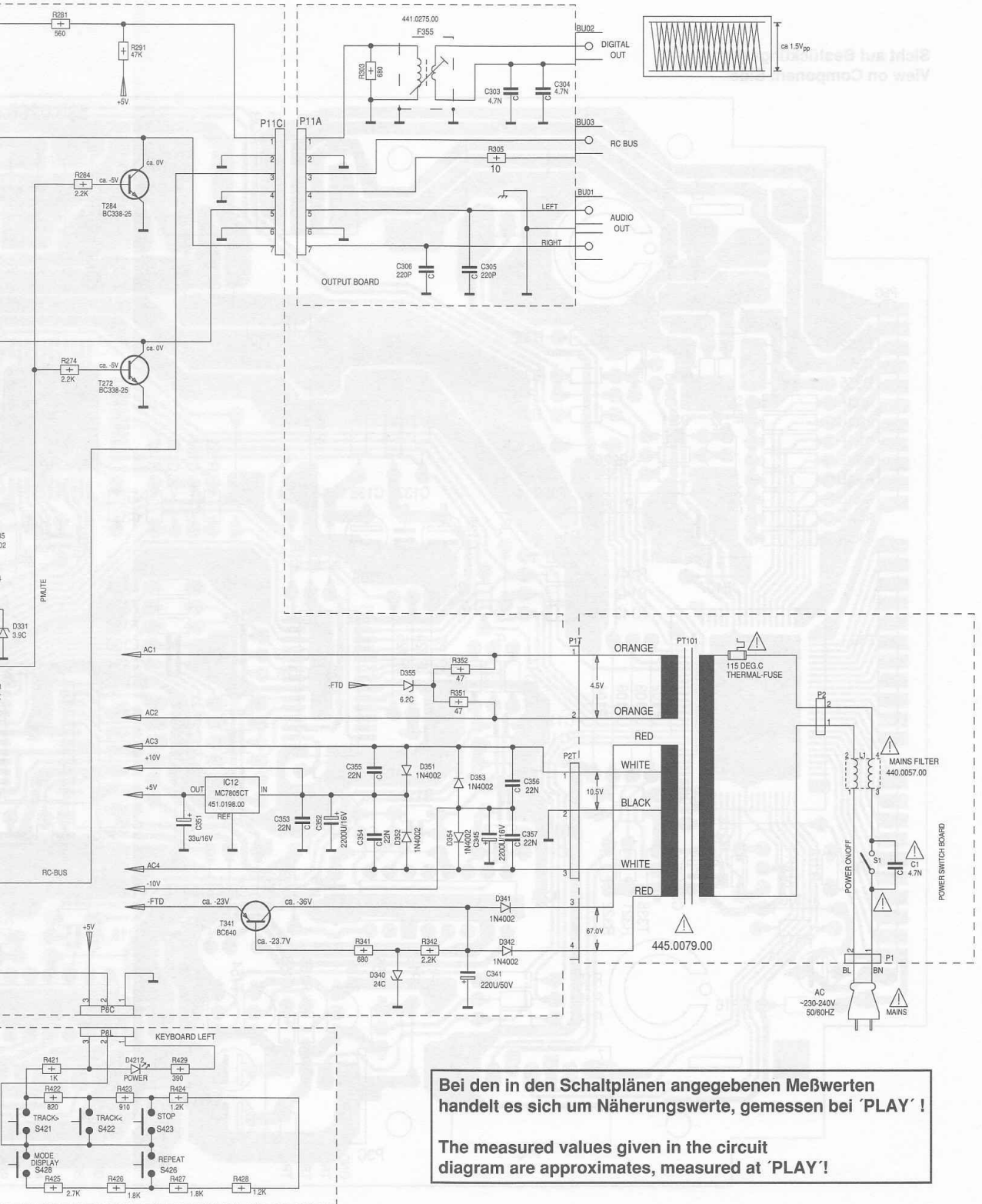

Bei den in den Schaltplänen angegebenen Meßwerten handelt es sich um Näherungswerte, gemessen bei 'PLAY' !

The measured values given in the circuit diagram are approximates, measured at 'PLAY' !

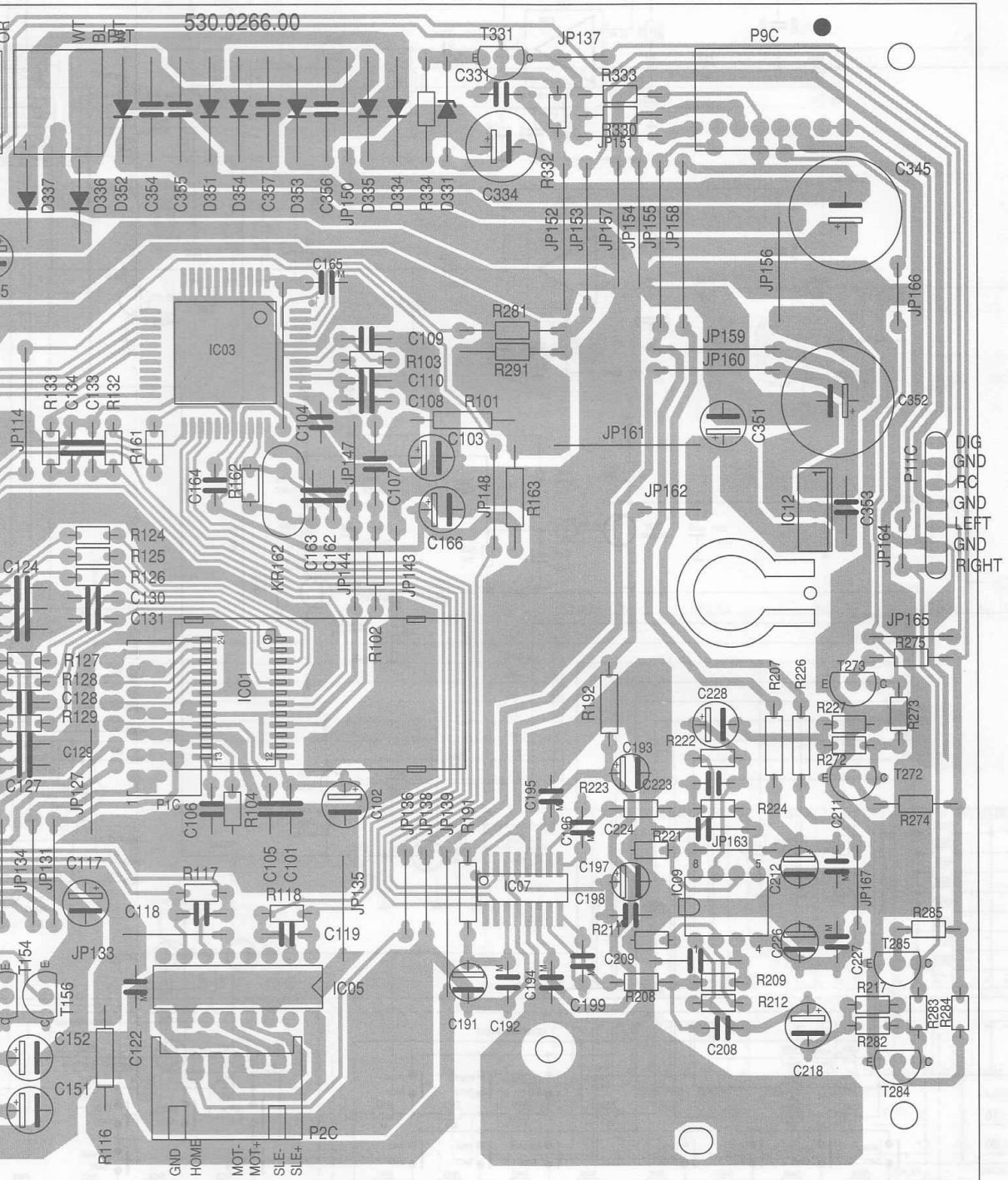

Sicht auf Lötseite
View on Solder Side

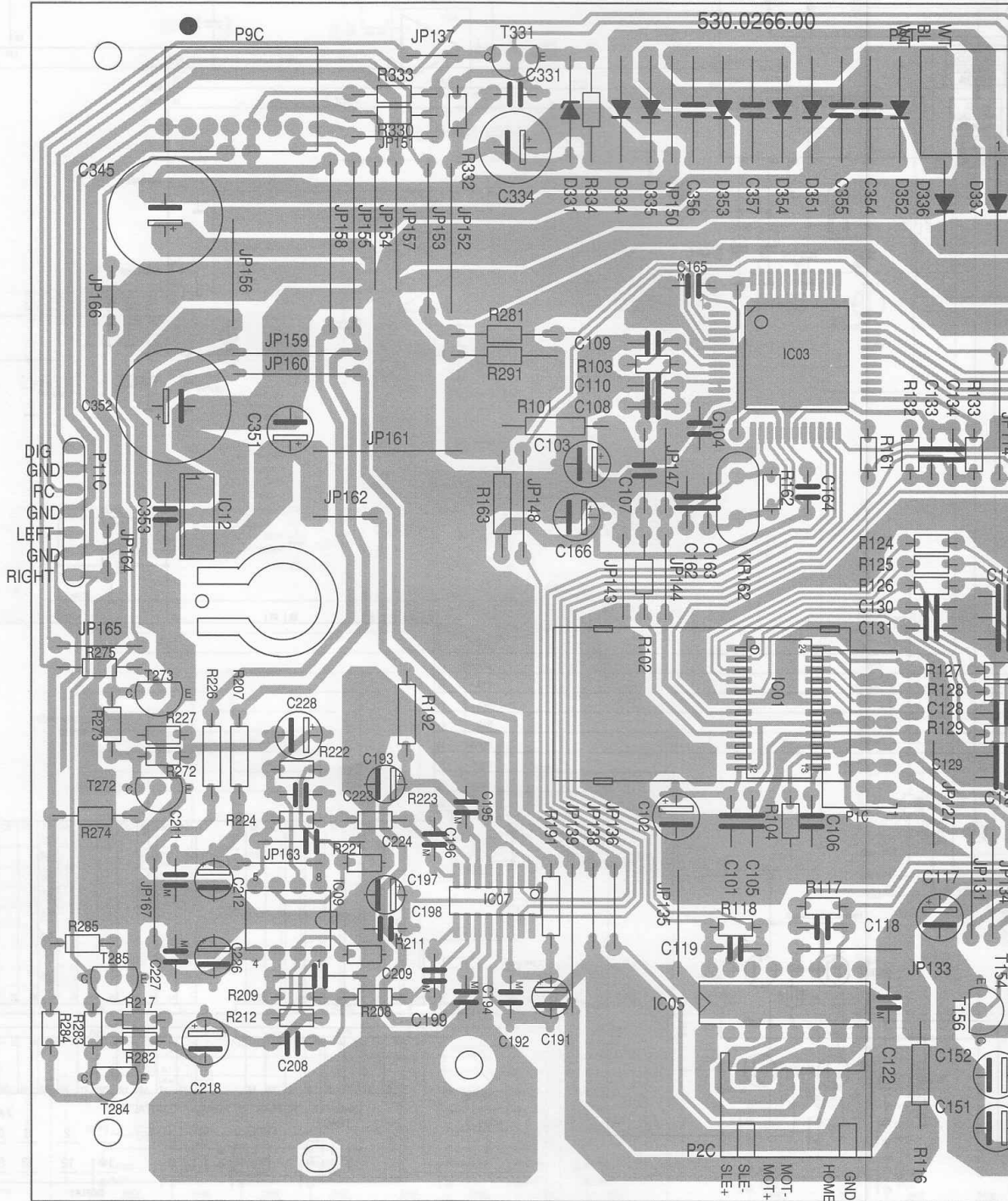

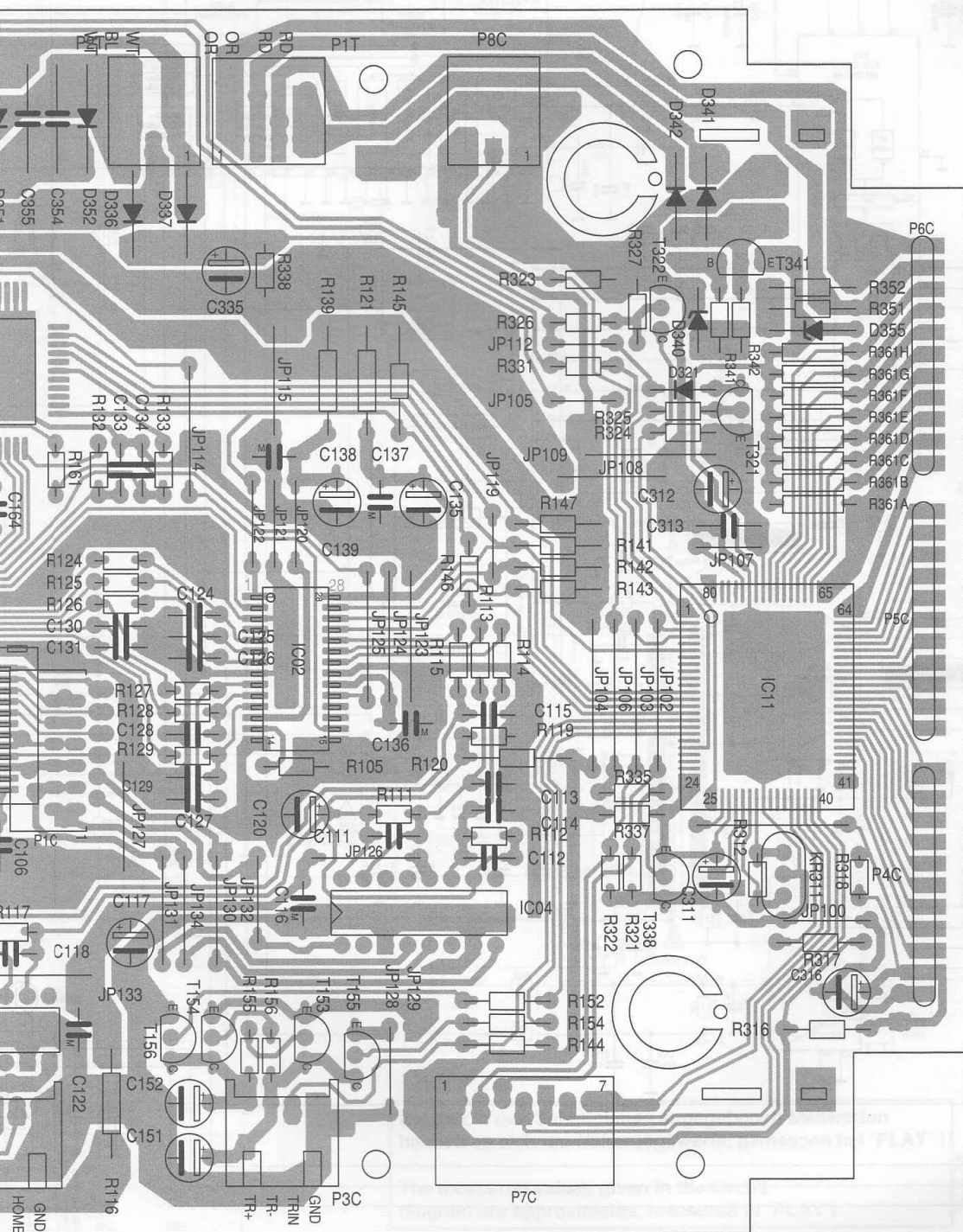

IC-Innenbeschaltungen
IC Block Diagrams

Tastenplatte rechts
Keyboard right

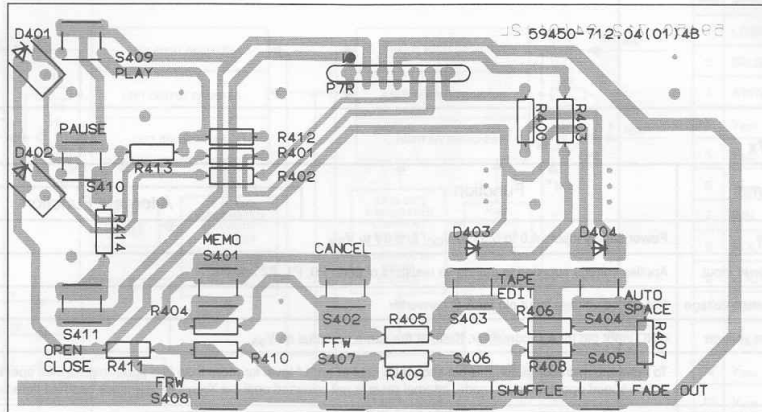

Tastenplatte links
Keyboard left

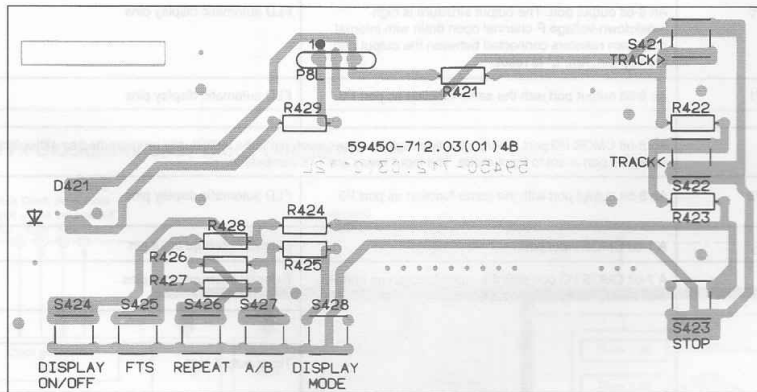

Anschlußplatte
Connecting Board

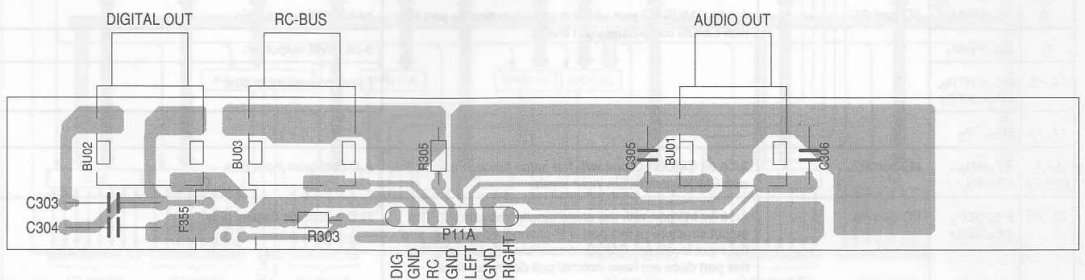

Netzschalterplatte Mains Switch Board

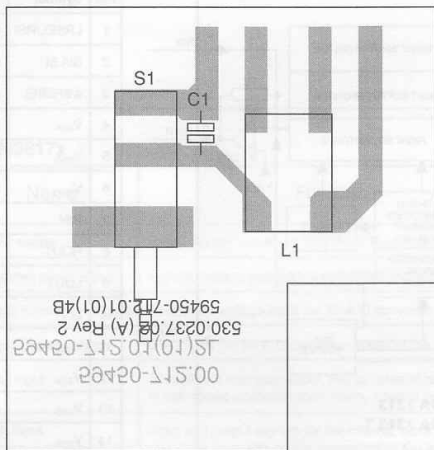

Displayplatte Display Board

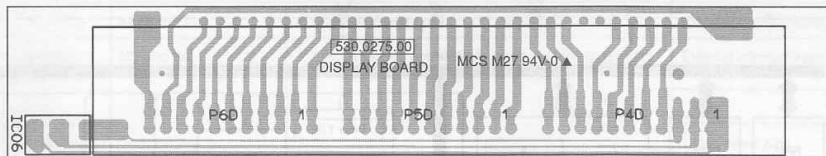

IC-Innenbeschaltungen IC Block Diagrams

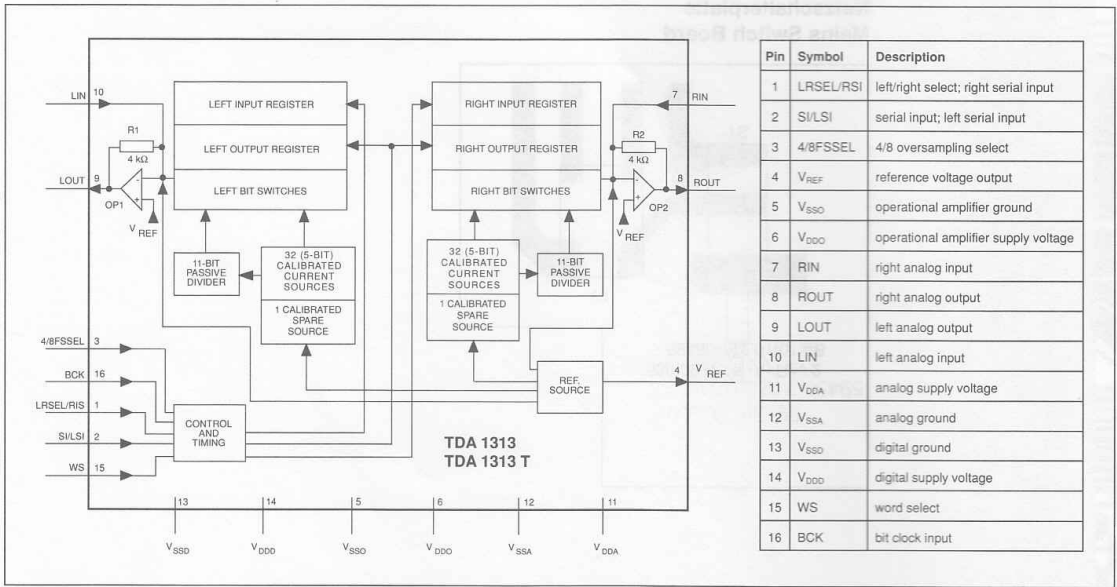

PIN DESCR

Pin

73, 32	V _{CC} , V _{EE}
74	V _{EE}
76	V _{REF}
75	AV _{SS}
27	RESET
30	X _{IN}
31	X _{OUT}
28	X _{CIN}
29	X _{COUT}
56 - 49	P ₀ /SE DIG ₀ - P ₀ /SE DIG ₇
48 - 41	P ₁ /DI P ₁ /DI
40 - 33	P ₂ - F
64 - 57	P ₃ /SE P ₃ /SE
26	P ₄ /IN
25 - 22	P ₄ /IN P ₄ /IN
21	P ₄ ₅
20, 19	P ₄ ₆ /T ₁ P ₄ ₇ /T ₃
12 - 9	P ₅ /SI P ₅ /SI P ₅ /SI P ₅ /SI P ₅ /SI P ₅ /SI
8 - 5	P ₅ ₄ /SI P ₅ ₅ /SI P ₅ ₆ /SI P ₅ ₇ /SI
18	P ₆ ₀ /PV
17	P ₆ ₁ /PV
16, 15	P ₆ ₂ /CN P ₆ ₃ /CN
14, 13	P ₆ ₄ , P ₆ ₅
4 - 1, 80 - 77	P ₇ ₀ /AN P ₇ ₁ /AN
72 - 65	P ₈ ₀ /SE P ₈ ₇ /SE

M3817x Blockschaltbild / Block Diagram

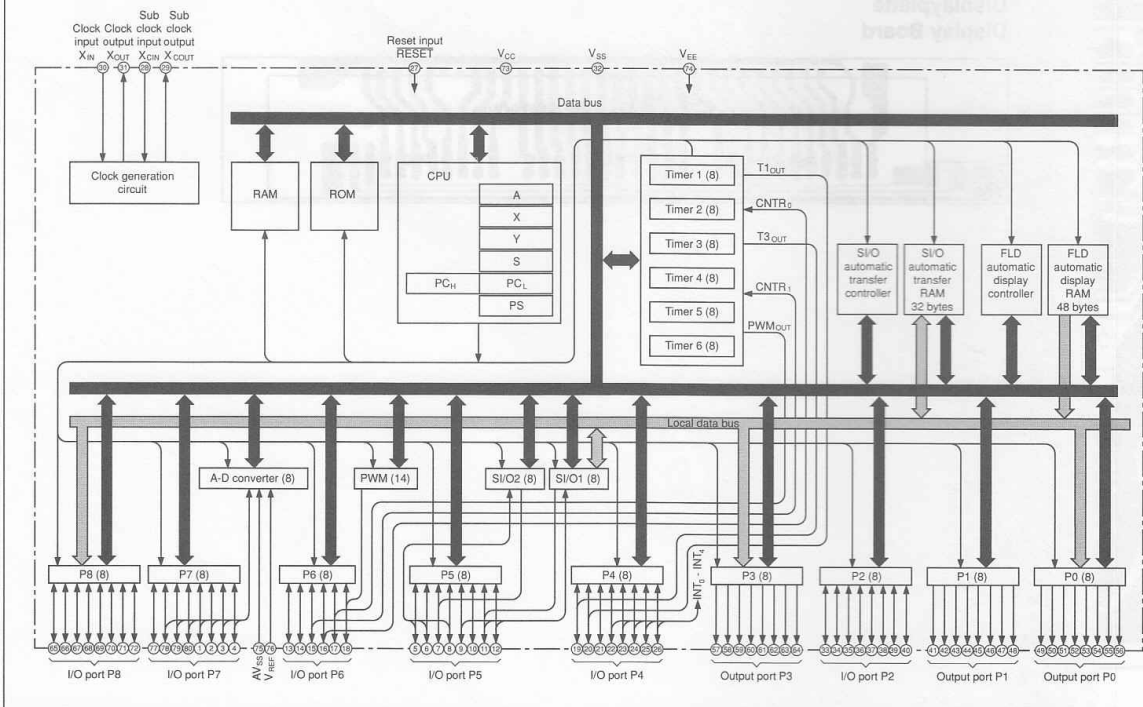

PIN DESCRIPTION M3817x

Pin	Name	Function	Alternate Function	
73, 32	V _{CC} , V _{SS}	Power supply	Power supply inputs 4.0 to 5.5V to V _{CC} , and 0V to V _{SS} .	
74	V _{EE}	Pull-down power input	Applies voltage supplied to pull-down resistors of ports P0, P1, P2 and P3.	
76	V _{REF}	Analog reference voltage	Reference voltage input pin for A-D converter.	
75	AV _{SS}	Analog power voltage	GND input pin for A-D converter. Keep at the same potential as V _{SS} .	
27	RESET	Reset input	To reset the microcomputer, this pin should be kept at an "L" level for more than 2μs under high-speed operating conditions. In low-speed operation start mode, internal reset is not released until the X _{CIN} - X _{COU} T clock has had time to stabilize.	
30	X _{IN}	Clock input	Input and output signals for the internal clock generation circuit. It consist of internal feedback amplifier. Connect a ceramic resonator or quartz crystal between the X _{IN} and X _{OUT} pins to set the oscillation frequency. If an external clock is used, connect the clock source to the X _{IN} pin and leave the X _{OUT} pin open. This clock is used as system clock.	
31	X _{OUT}	Clock output		
28	X _{CIN}	Sub clock input	Input and output signals for the internal sub clock generation circuit. It consist of internal amplifier without feedback. Connect a ceramic resonator or quartz crystal and external feedback resistor between the X _{CIN} and X _{COU} T pins. If an external clock is used, connect the clock source to the X _{CIN} pin and leave the X _{COU} T pin open. This clock can also be used as the system clock.	
29	X _{COU} T	Sub clock output		
56 - 49	P0 ₀ /SEG ₁₆ / DIG ₀ - P0 ₇ /SEG ₂₃ / DIG ₇	Output port P0	An 8-bit output port. The output structure is high-breakdown-voltage P-channel open drain with internal pull-down resistors connected between the output and the V _{EE} pin. Are "L" at reset.	FLD automatic display pins
48 - 41	P1 ₀ /DIG ₈ - P1 ₇ /DIG ₁₅	Output port P1	An 8-bit output port with the same function as port P0.	FLD automatic display pins
40 - 33	P2 ₀ - P2 ₇	I/O port P2	An 8-bit CMOS I/O port. An I/O direction register allows each pin to be individually programmed as either input or output. At reset this port is set to input mode. The input levels are TTL compatible.	
64 - 57	P3 ₀ /SEG ₈ - P3 ₇ /SEG ₁₅	Output port P3	An 8-bit output port with the same function as port P0.	FLD automatic display pins
26	P4 ₀ /INT ₀	Input port P4 ₀	A 1-bit CMOS input pin.	External interrupt input pin
25 - 22	P4 ₁ /INT ₁ - P4 ₄ /INT ₄	I/O port P4	A 7-bit CMOS I/O port with the same function as port P2, with CMOS compatible input levels.	External interrupt input pins
21	P4 ₅			
20, 19	P4 ₆ /T1OUT, P4 ₇ /T3OUT			Timer output pins
12 - 9	P5 ₀ /SIN ₁ , P5 ₁ /SOUT ₁ , P5 ₂ /SCLK ₁ , P5 ₃ /SRDY ₁ / CS/SCLK ₁₂	I/O port P5	An 8-bit I/O port with the same function as port P2. The output structure of this port is N-channel open drain, and the input levels are CMOS compatible. Keep the input voltage of this port between 0V and V _{CC} .	Serial I/O1 I/O pins
8 - 5	P5 ₄ /SIN ₂ , P5 ₅ /SOUT ₂ , P5 ₆ /SCLK ₂ , P5 ₇ /SRDY ₂			Serial I/O2 I/O pins
18	P6 ₀ /PWM ₀	I/O port P6	A 6-bit CMOS I/O port with the same function as port P2, with CMOS compatible input levels.	14-bit PWM output pin
17	P6 ₁ /PWM ₁			8-bit PWM output pin
16, 15	P6 ₂ /CNTR ₀ , P6 ₃ /CNTR ₁			Event counter input pins
14, 13	P6 ₄ , P6 ₅			
4 - 1, 80 - 77	P7 ₀ /AN ₀ - P7 ₇ /AN ₇	I/O port P7	An 8-bit CMOS I/O port with the same function as port P2, with CMOS compatible input levels.	A-D converter input pins
72 - 65	P8 ₀ /SEG ₀ - P8 ₇ /SEG ₇	I/O port P8	An 8-bit I/O port with the same function as port P2. The output structure of this port is P-channel open drain, and the input levels are CMOS compatible. Please note that this port does not have internal pull-down resistors.	FLD automatic display pins

Ersatzteilliste und Explosionszeichnungen

Spare Parts List and Exploded Views

Explosionszeichnung Gerät

Exploded View Unit

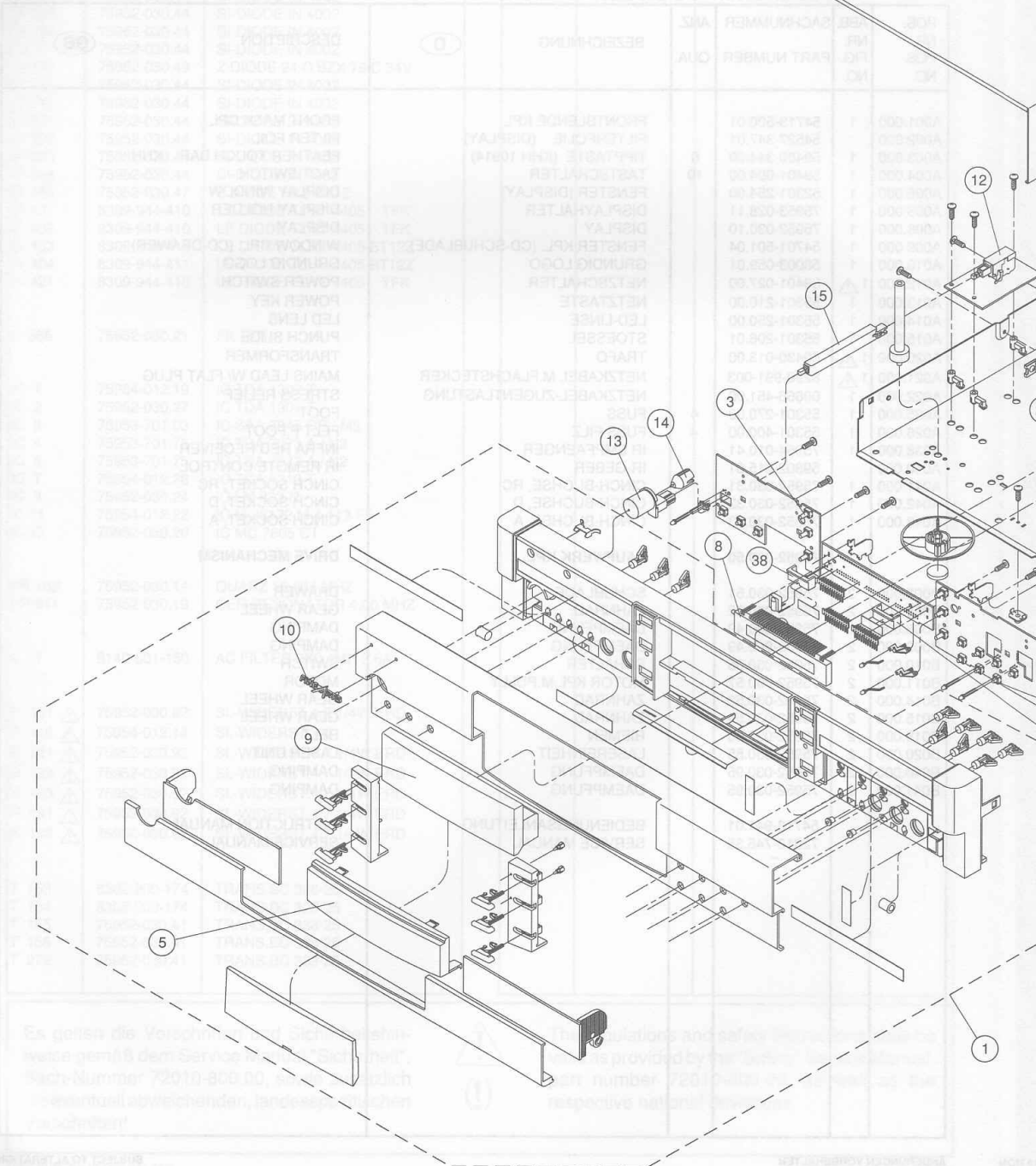

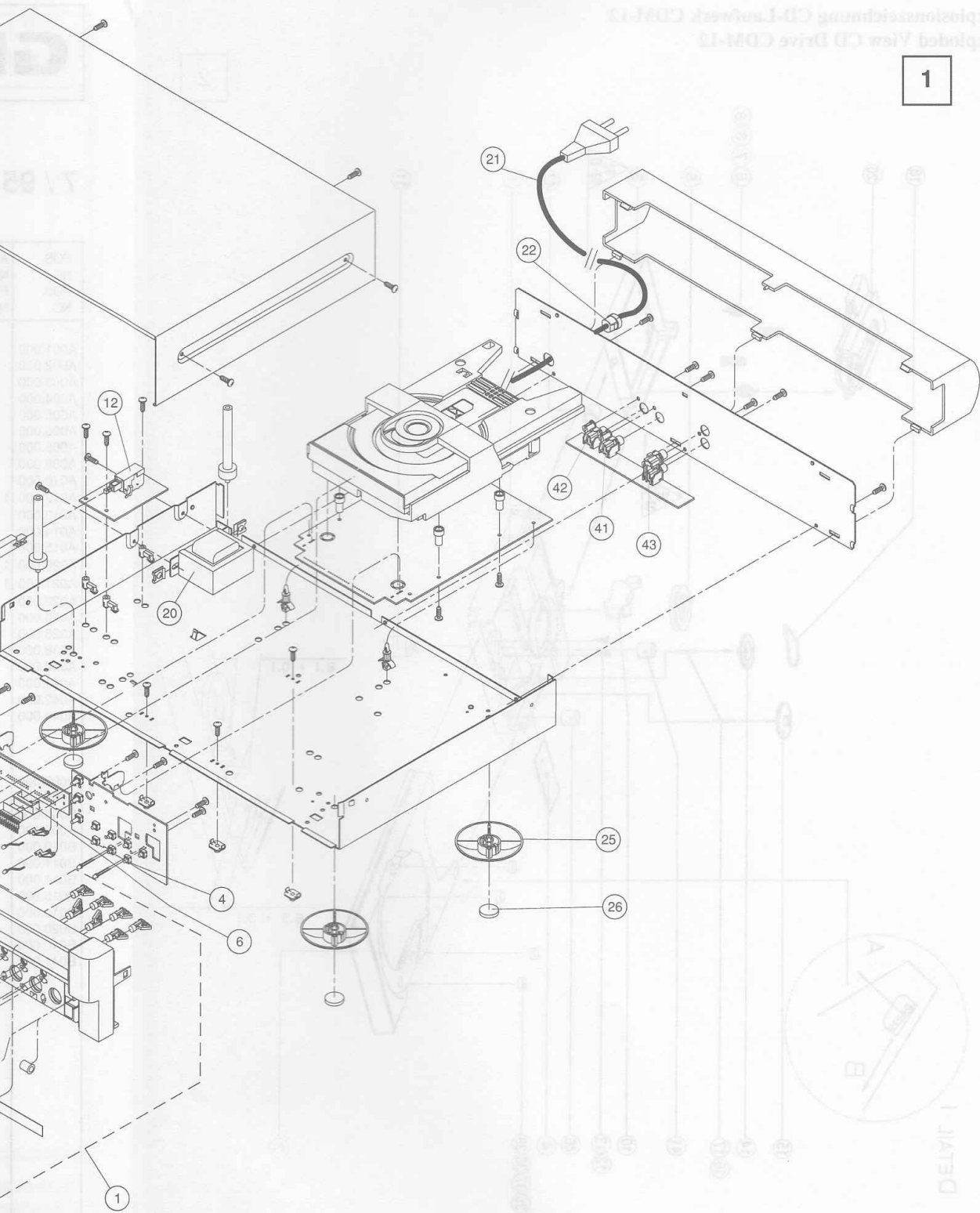

1

Explosionszeichnung CD-Laufwerk CDM-12
Exploded View CD Drive CDM-12

2

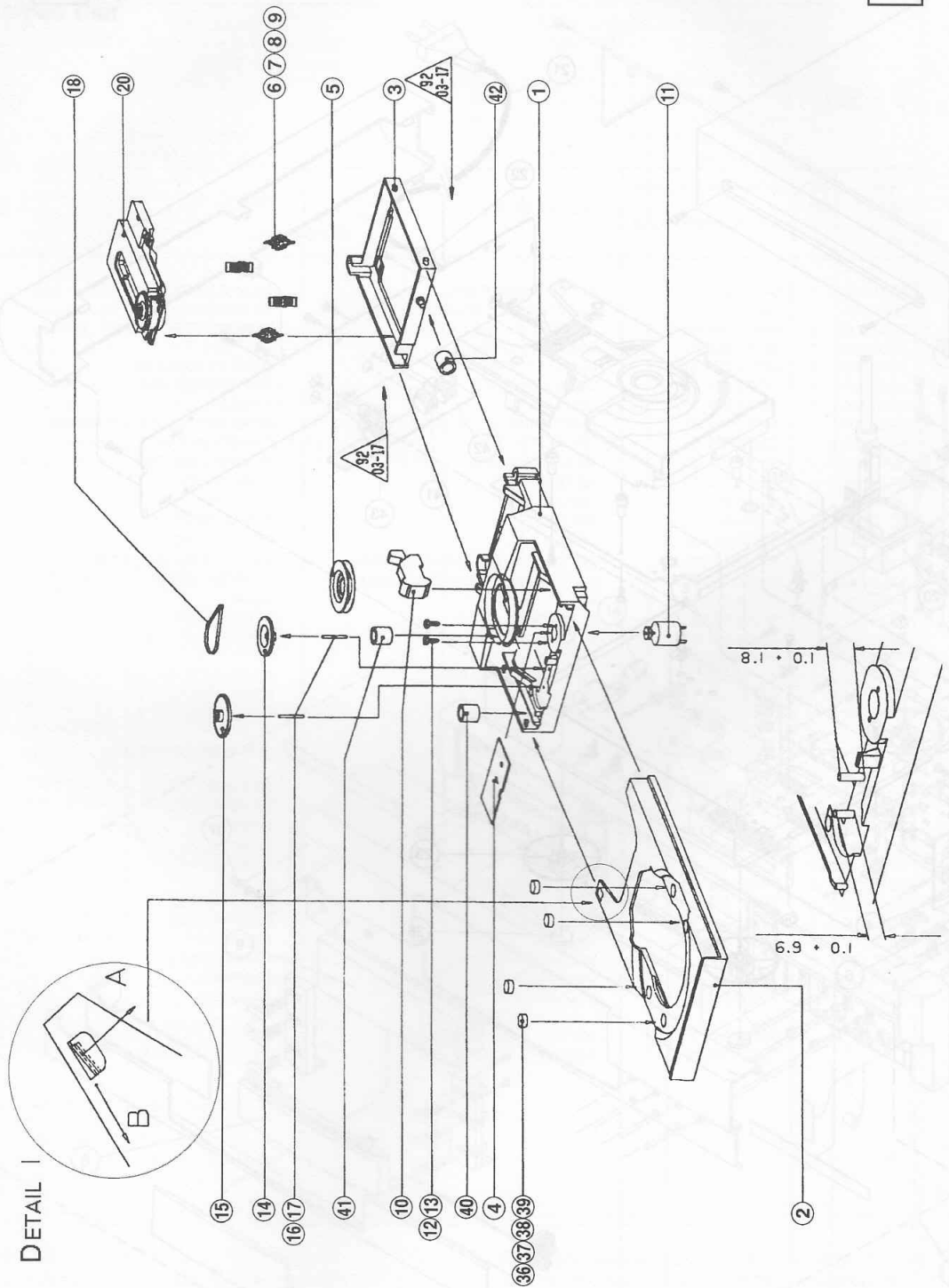

GRUNDIGErsatzteilliste
Spare Parts List

D Btx * 32700 #

7 / 95

CD 11

SACH-NR. / PART NO.: 9.54713-8151
BESTELL-NR. / ORDER NO.: G.LE 3851

POS. NR. POS. NO.	ABB. NR. FIG. NO.	SACHNUMMER PART NUMBER	ANZ. QUA.	BEZEICHNUNG (D)	DESCRIPTION (GB)
A001.000	1	54713-500.01		FRONTBLLENDE KPL	FRONT MASK CPL
A002.000		54527-347.01		FILTERFOLIE (DISPLAY)	FILTER FOIL
A003.000	1	59400-344.00	6	TIPPTASTE (KHH 10914)	FEATHER TOUCH BAR KHH
A004.000	1	59401-004.00	10	TASTSCHALTER	TACT SWITCH
A005.000	1	52301-254.00		FENSTER (DISPLAY)	DISPLAY WINDOW
A006.000	1	75953-028.11		DISPLAYHALTER	DISPLAY HOLDER
A008.000	1	75952-030.10		DISPLAY	DISPLAY
A009.000	1	54701-501.04		FENSTER KPL. (CD-SCHUBLADE)	WINDOW CPL. (CD-DRAWER)
A010.000	1	58003-059.01		GRUNDIG LOGO	GRUNDIG LOGO
A012.000	1 Δ	59401-027.00		NETZSCHALTER	POWER SWITCH
A013.000	1	55301-210.00		NETZTASTE	POWER KEY
A014.000	1	55301-250.00		LED-LINSE	LED LENS
A015.000	1	55301-206.01		STOESSEL	PUNCH SLIDE
A020.000	1 Δ	59430-013.00		TRAFO	TRANSFORMER
A021.000	1 Δ	8290-991-003		NETZKABEL M.FLACHSTECKER	MAINS LEAD W/ FLAT PLUG
A022.000	1	09666-451.00		NETZKABEL-ZUGENTLASTUNG	STRESS RELIEF
A025.000	1	55301-270.00	4	FUSS	FOOT
A026.000	1	55301-400.00	4	FUSS FILZ	FELT F.FOOT
A038.000	1	75954-010.41		IR EMPFAENGER	INFRA RED RECEIVER
A040.000		59802-615.01		IR-GEBER	IR REMOTE CONTROL
A041.000	1	75952-030.31		CINCH-BUCHSE, RC	CINCH SOCKET, RC
A042.000	1	75952-030.32		CINCH-BUCHSE, D	CINCH SOCKET, D
A043.000	1	75952-030.33		CINCH-BUCHSE, A	CINCH SOCKET, A
		75952-030.50		LAUFWERK KPL.	DRIVE MECHANISM
B002.000	2	75952-030.51		SCHUBLADE	DRAWER
B005.000	2	75952-030.52		ZAHNRAD	GEAR WHEEL
B006.000	2	75953-800.49		DAEMPfung	DAMPING
B009.000	2	75953-800.49		DAEMPfung	DAMPING
B010.000	2	75952-030.05		SCHALTER	SWITCH
B011.000	2	75952-030.57		MOTOR KPL.M.PULLY	MOTOR
B014.000	2	75952-030.53		ZAHNRAD	GEAR WHEEL
B015.000	2	75952-030.54		ZAHNRAD	GEAR WHEEL
B018.000	2	75952-030.56		RIEMEN	BELT
B020.000	2	75952-030.55		LASEREINHEIT	LASER UNIT
B040.000	2	75952-030.95		DAEMPfung	DAMPING
B041.000	2	75952-030.95		DAEMPfung	DAMPING
		54713-941.01		BEDIENUNGSANLEITUNG	INSTRUCTION MANUAL
		72010-745.35		SERVICE MANUAL	SERVICE MANUAL

POS. NR. POS. NO.	SACHNUMMER PART NUMBER	BEZEICHNUNG DESCRIPTION	(D) (GB)	POS. NR. POS. NO.	SACHNUMMER PART NUMBER	BEZEICHNUNG DESCRIPTION	(D) (GB)
C 1	8660-197-042	SI-KERKO.A 3300PF 20%		T 273	75952-030.39	TRANS.BC 548 B	
C 345	8410-015-107	ELKO 2200UF 16V UVR NICH/		T 284	75952-030.41	TRANS.BC 338-25	
C 352	8410-015-107	ELKO 2200UF 16V UVR NICH/		T 285	75952-030.39	TRANS.BC 548 B	
D 321	75952-030.43	SI-DIODE 1 N 4148		T 321	75952-030.38	TRANS.BC 558 B	
D 331	75952-030.46	Z DIODE 3,9 V 500MW		T 322	75952-030.39	TRANS.BC 548 B	
D 334	75952-030.44	SI-DIODE IN 4002		T 331	75952-030.38	TRANS.BC 558 B	
D 335	75952-030.44	SI-DIODE IN 4002		T 338	75952-030.38	TRANS.BC 558 B	
D 336	75952-030.44	SI-DIODE IN 4002		T 341	75952-030.76	TRANS.PNP BC 640	
D 337	75952-030.44	SI-DIODE IN 4002					
D 340	75952-030.49	Z DIODE 24 C BZX 79 C 34V					
D 341	75952-030.44	SI-DIODE IN 4002					
D 342	75952-030.44	SI-DIODE IN 4002					
D 351	75952-030.44	SI-DIODE IN 4002					
D 352	75952-030.44	SI-DIODE IN 4002					
D 353	75952-030.44	SI-DIODE IN 4002					
D 354	75952-030.44	SI-DIODE IN 4002					
D 355	75952-030.47	Z DIODE HZS 6 C 2					
D 401	8309-944-410	LE DIODE TLHY 4405 TFK					
D 402	8309-944-410	LE DIODE TLHY 4405 TFK					
D 403	8309-944-411	LE DIODE TLHY 4405 BT12Z					
D 404	8309-944-411	LE DIODE TLHY 4405 BT12Z					
D 421	8309-944-410	LE DIODE TLHY 4405 TFK					
F 355	75952-030.21	FILTER					
IC 1	75954-012.19	IC TDA 1302 T					
IC 2	75952-030.27	IC TDA 1301 T					
IC 3	75953-701.03	IC SAA 7345 GP / M5					
IC 4	75953-701.75	IC TDA 7073 A / N2					
IC 5	75953-701.75	IC TDA 7073 A / N2					
IC 7	75954-012.26	IC TDA 1313 T					
IC 9	75952-030.24	IC LM 833 N					
IC 11	75954-012.22	IC M 38172 M 4-113 FP					
IC 12	75952-030.26	IC MC 7805 CT					
KR 162	75952-030.14	QUARZ 16,934 MHZ					
KR 311	75952-030.19	CER RESONATOR 4,00 MHZ					
L 1	8140-601-150	AC FILTER 2X0,4MH 2,6A					
R 101	75952-030.92	SI.-WIDERST.4,7 1/4W ERD					
R 116	75954-012.14	SI.-WIDERST.1,0					
R 121	75952-030.92	SI.-WIDERST.4,7 1/4W ERD					
R 139	75952-030.92	SI.-WIDERST.4,7 1/4W ERD					
R 163	75952-030.92	SI.-WIDERST.4,7 1/4W ERD					
R 191	75952-030.92	SI.-WIDERST.4,7 1/4W ERD					
R 192	75952-030.92	SI.-WIDERST.4,7 1/4W ERD					
T 153	8302-200-174	TRANS.BC 328-25					
T 154	8302-200-174	TRANS.BC 328-25					
T 155	75952-030.41	TRANS.BC 338-25					
T 156	75952-030.41	TRANS.BC 338-25					
T 272	75952-030.41	TRANS.BC 338-25					

Es gelten die Vorschriften und Sicherheitshinweise gemäß dem Service Manual "Sicherheit", Sach-Nummer 72010-800.00, sowie zusätzlich die eventuell abweichenden, landesspezifischen Vorschriften!



The regulations and safety instructions shall be valid as provided by the "Safety" Service Manual, part number 72010-800.00, as well as the respective national deviations.